



# IGNITERS AND THEIR USE

By Bob Cannon; Revised by Mary Roberts, Ann Grimm and Kathleen Greer

Electrical igniters are simple devices which permit you to launch your model rocket by remote control. The ignition system provides electrical current to the igniter. The igniter heats. The heat produced by the igniter causes the propellant in the engines to start burning, and your rocket

to the key element in the igniter, the bridge wire. This bridge wire is a high resistance wire which becomes hot when electricity flows through it. The heat provided by this bridge wire heats the propellant in the model rocket engine to initiate combustion. (Figure A)

The coating on the tip protects the thin bridge wire and gives strength to the igniter tip. The bridge wire is welded at each end to a lead wire. The coating also

are not broken. The heat produced by the bridge wire when the proper amount of electricity passes through it is enough to cause ignition of the propellant in the model rocket engine if the igniter tip is in direct contact with the propellant. The wire will heat to over 550° Fahrenheit (282° Celsius). This is enough heat to initiate combustion of the propellant.

Usually the bridge wire will burn into two pieces when the

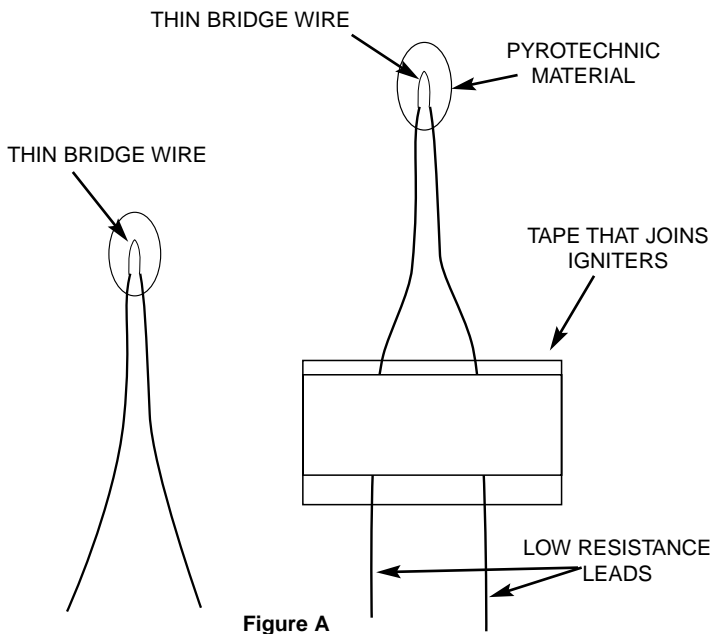

Figure A

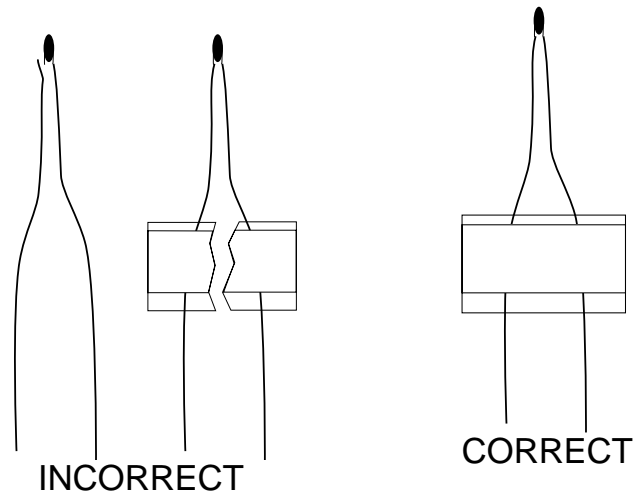

Figure B

zooms off the launch pad.

Igniters can be difficult. They work great when they are used right, but you have to use them correctly to get the reliable ignition you want for your launches. This article will review some basics for the care and use of Estes igniters.

Estes igniters are carefully manufactured to cause prompt ignition of your model rocket engines. The lead wires are low resistance wires that connect your ignition system

serves as an insulator and spacer to keep the lead wire from touching at the tip and “shorting out” at the tip of the igniter. The pyrotechnic material also burns when heated by the bridge wire and provides extra heat to produce fast ignition. (Figure A)

Occasionally, the coating on the tip of the igniter may be cracked or even chipped off by the time you receive the igniter. The igniter will still work if the bridge wire welds

igniter is used. Occasionally, the bridge wire will not burn into two pieces. Do not try to reuse an igniter. Even if the bridge wire is intact, you cannot depend on the igniter to work a second time due to changes produced when it first heated.

Never remove the tape from the igniter leads! Do not tear or cut the tape between the two leads of the same igniter. This tape holds the lead wires in place to help prevent their shorting and to provide strength to hold the igniter's shape. (Figure B) You may tear or cut the tape to separate the two igniters.

Over 90% of all ignition problems are traceable to improper insertion and/or improper securing of the igniters.

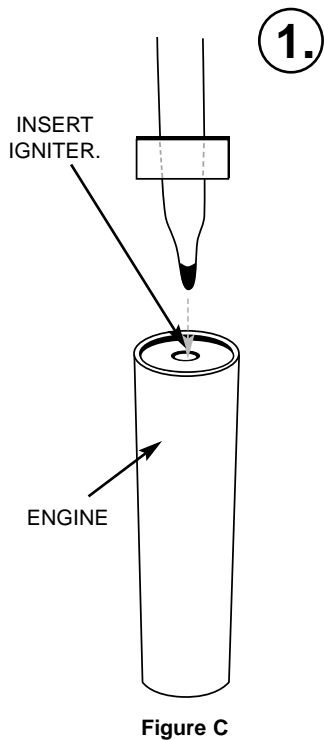

Figure C

The keys to successful igniter insertion are to insert the igniter all the way to the bottom of the nozzle and to secure the igniter firmly in place. If the igniter tip does not actually touch the propellant, the igniter will “burn”, but the propellant will not be heated enough to initiate combustion. If the igniter is not firmly secured in the correct position, even the small weight of a micro-clip and its lead wire may be enough to pull the igniter slightly away from the propellant.

**THE IGNITER MUST TOUCH THE PROPELLANT DEEP INSIDE THE NOZZLE.**

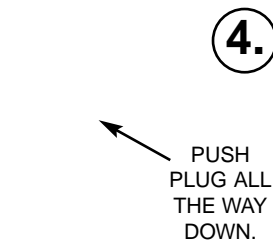
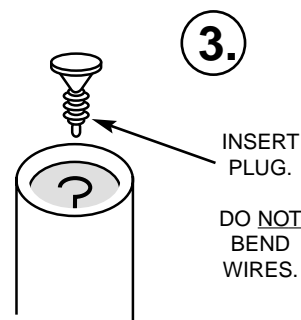
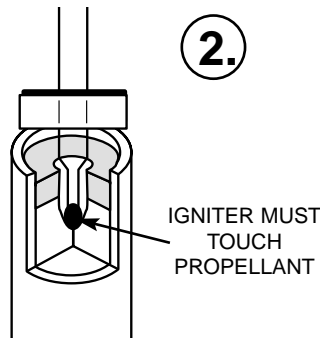
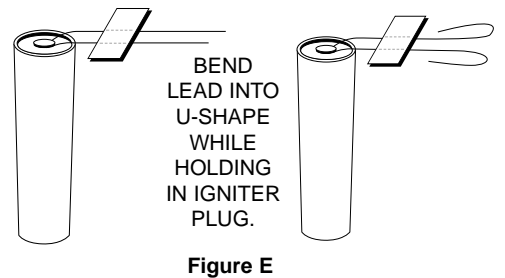

Figure D

After the igniter is properly inserted, push an igniter plug into the nozzle. This will bend the lead wires to one side. Do not bend the lead wires! Bending the wires before inserting the plug will pull the tip of the igniter away from the propellant. (Figure D)

After inserting the igniter and igniter plug in your model rocket engine, carefully bend igniter wires back and form leads into a “U-shape.” (Figure E) This provides two points to which each micro-

clip is attached instead of one. This will give you a better chance of not having an ignition failure because of bent or dirty micro-clips. (Figure F)



Once the igniter is securely inserted in the model rocket engine, the engine is ready to be inserted into the rocket. After inserting the engine and igniter into the model rocket, place the rocket on the launch pad. The usual manner is for the launch rod to go through the launch lug(s). Now you are ready to attach the micro-clips. Make sure micro-clips are clean. Attach the micro-clips to the igniter as shown in Figure F. Make sure that the micro-clips do not touch each other, the launch rod or the blast deflector plate. Move away from the rocket and prepare for countdown.

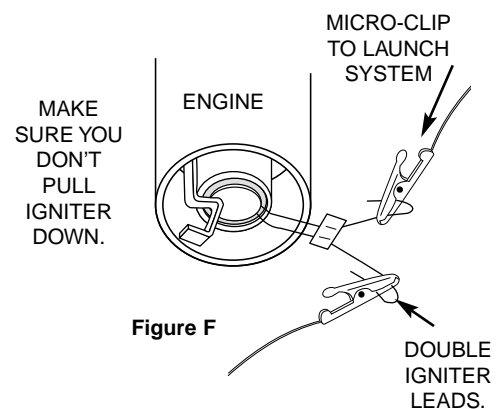

If the igniter heats and burns the coating, it has done its job - making heat to initiate combustion. Sometimes it is possible to see a small puff of smoke from the nozzle when the launch button is pushed, but the rocket does not lift off. This means that the igniter worked properly, but it was not touching the propellant deep inside the engine. Even the tiniest gap can prevent ignition.

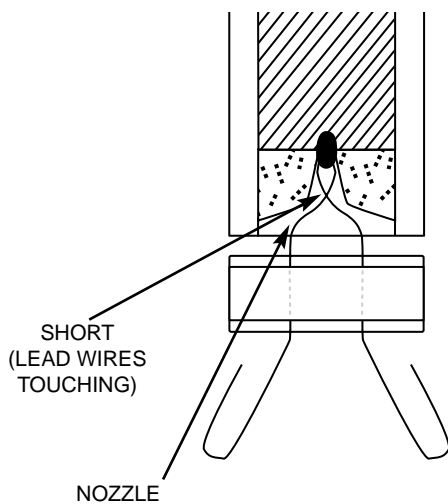

Figure G

If the igniter fails to heat and burn off the coating, the lead wires may be crossed, perhaps inside the nozzle beneath the igniter plug where the short cannot be seen. (Figure G) This accidental touching of the leads is called “shorting” because the path the electricity should take is shortened. The electricity follows the path of least resistance and the igniter does not

**DO NOT APPROACH  
THE LAUNCH PAD  
WHILE THE SAFETY  
KEY IS INSERTED IN  
THE LAUNCHER.**

function properly.

The only need for extra igniters should be for replacement in case an igniter is accidentally damaged or is not properly positioned and secured in place.

About the only ways an igniter can fail are a broken weld (the bridge wire between the two larger lead wires must be intact and attached to each end to the lead wires), the lead wires touching (shorts out the circuit so the electricity does not heat the bridge wire), failure to insert the igniter fully into the nozzle or the igniter not being properly secured (it comes slightly away from the propellant).

If you discover a broken igniter, return the igniter to Estes. We will gladly replace it, but we need the defective igniters to determine the cause of the defect.

If you have done all steps properly and your model rocket did not launch, **REMOVE THE SAFETY KEY FROM YOUR IGNITION SYSTEM AND WAIT ONE MINUTE.**

Next, detach the micro-clips from the igniter and remove your rocket from the launch pad. Carefully remove the igniter plug and igniter from the engine. Check the igniter. If the pyrotechnic coating is burned off and/or the bridge wire is burned into two pieces, the igniter worked but was not touching the propellant. Properly insert a new igniter and igniter plug in the engine and try again.

Problems with ignition can be caused by a weak power supply, dirty or not properly closing micro-clips or a loose connection in the launch controller. If you have a problem which does not appear to be caused by an igniter, be sure to check your ignition sys-

tem. Attach the micro-clips to each other. Then insert the safety key. Do not leave the launch control system in this condition very long as this will drain your batteries very rapidly. The continuity light should glow white or bright yellow. If it is orange, one or more of the batteries may be weak. Always use alkaline batteries. The supposed “heavy duty” or standard batteries often do not produce adequate amperage for more than four to six launches. The batteries in your launch system should produce a total of at least half an ampere at six or more volts.

For more information on ignition systems, see the Estes publication Model Rocket Launch Systems (EST 2811).



ESTES INDUSTRIES  
1295 H Street  
Penrose Colorado 81240

# Igniter Installation

About 90% of all problems with engine ignition are caused by the igniter not being properly installed and securely held in place in the engine.

The igniter **must touch** the propellant at the moment the igniter is heated for ignition.

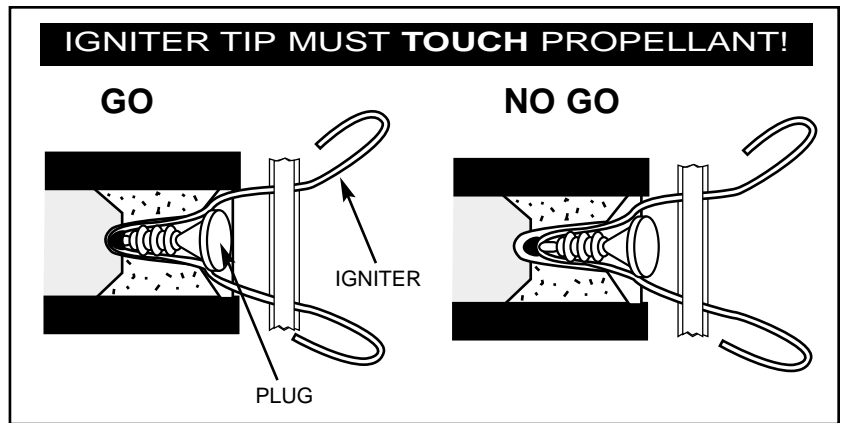

## MODEL ROCKET IGNITER INSTALLATION

Always use electrical model rocket igniters with a model rocket launch controller.

1. Cut tape separating igniters. Do not remove tape.

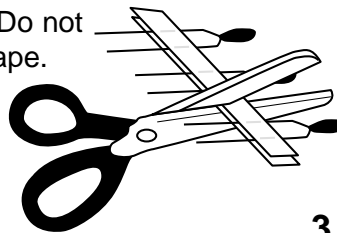

2. Separate plug from strip of plugs.



3. Insert igniter into engine. Igniter must touch propellant. Do NOT bend igniter.

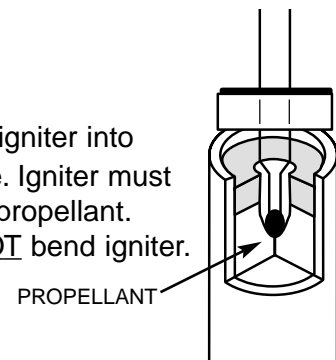

4. Insert plug into engine nozzle.

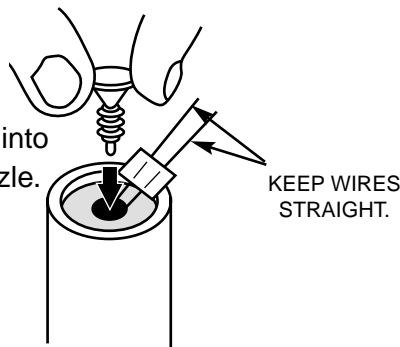

5. Push plug firmly into engine.

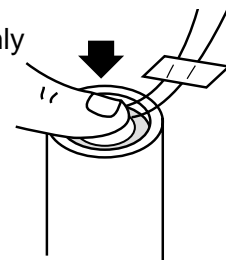

HOLD DOWN PLUG WITH THUMB WHEN YOU BEND WIRES.

6. Bend igniter wires back and form leads as shown.

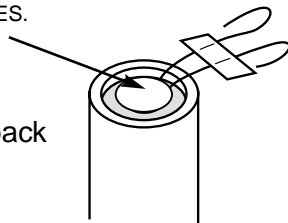

7. Make sure micro-clips are clean. Attach micro-clips to the igniter wire leads as shown. Arrange the clips so they do not touch each other, the launch rod or the metal blast deflector.

